

135 μ A, 14nV/ $\sqrt{\text{Hz}}$, Rail-to-Rail Output Precision Op Amp with Shutdown

FEATURES

- 35 μ V Maximum Offset Voltage
- 110pA Maximum Input Bias Current
- 135 μ A Supply Current
- Rail-to-Rail Output Swing
- 12 μ A Supply Current in Shutdown
- 120dB Minimum Voltage Gain ($V_S = \pm 15\text{V}$)
- 0.8 $\mu\text{V}/^\circ\text{C}$ Maximum V_{OS} Drift
- 14nV/ $\sqrt{\text{Hz}}$ Input Noise Voltage
- 2.7V to $\pm 18\text{V}$ Supply Voltage Operation
- Operating Temperature Range: -40°C to 85°C
- Space Saving 3mm \times 3mm DFN Package

APPLICATIONS

- Thermocouple Amplifiers
- Precision Photo Diode Amplifiers
- Instrumentation Amplifiers
- Battery-Powered Precision Systems

DESCRIPTION

The LT[®]6010 op amp combines low noise and high precision input performance with low power consumption and rail-to-rail output swing.

Input offset voltage is trimmed to less than 35 μV . The low drift and excellent long-term stability guarantee a high accuracy over temperature and over time. The 110pA maximum input bias current and 120dB minimum voltage gain further maintain this precision over operating conditions.

The LT6010 works on any power supply voltage from 2.7V to 36V, and draws only 135 μA of supply current on a 5V supply. A power saving shutdown feature reduces supply current to 12 μA . The output voltage swings to within 40mV of either supply rail, making the amplifier a good choice for low voltage single supply operation.

The LT6010 is fully specified at 5V and $\pm 15\text{V}$ supplies and from -40°C to 85°C . The device is available in SO-8 and space-saving 3mm \times 3mm DFN packages. This op amp is also available in dual (LT6011) and quad (LT6012) packages.

 LTC and LT are registered trademarks of Linear Technology Corporation.

TYPICAL APPLICATION

Single Supply Current Source for Platinum RTD

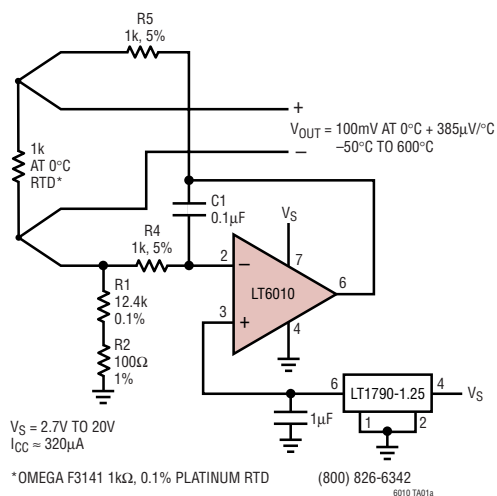

Distribution of Offset Voltage Drift

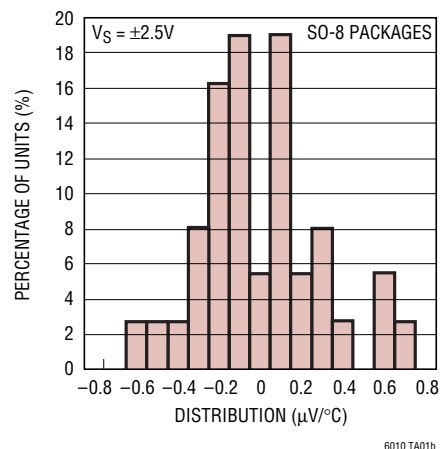

LT6010

ABSOLUTE MAXIMUM RATINGS (Note 1)

| | | | |
|---|-------------------|--|----------------|
| Total Supply Voltage (V^+ to V^-) | 40V | Maximum Junction Temperature | |
| Differential Input Voltage (Note 2) | 10V | DD Package | 125°C |
| Input Voltage, Shutdown Voltage | V^+ to V^- | SO-8 Package | 150°C |
| Input Current (Note 2) | $\pm 10\text{mA}$ | Storage Temperature Range | |
| Output Short-Circuit Duration (Note 3) | Indefinite | DD Package | -65°C to 125°C |
| Operating Temperature Range (Note 4) .. | -40°C to 85°C | SO-8 Package | -65°C to 150°C |
| Specified Temperature Range (Note 5) ... | -40°C to 85°C | Lead Temperature (Soldering, 10 sec) | 300°C |

PACKAGE/ORDER INFORMATION

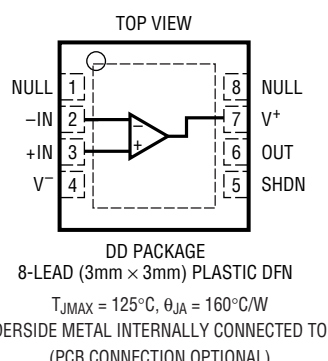
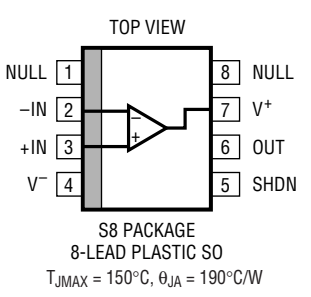
| | | | |
|--|--|--|--|
|  <p>DD PACKAGE 8-LEAD (3mm x 3mm) PLASTIC DFN $T_{JMAX} = 125^{\circ}\text{C}$, $\theta_{JA} = 160^{\circ}\text{C/W}$ UNDERSIDE METAL INTERNALLY CONNECTED TO V^- (PCB CONNECTION OPTIONAL)</p> | ORDER PART NUMBER |  <p>S8 PACKAGE 8-LEAD PLASTIC SO $T_{JMAX} = 150^{\circ}\text{C}$, $\theta_{JA} = 190^{\circ}\text{C/W}$</p> | ORDER PART NUMBER |
| | LT6010CDD LT6010IDD LT6010ACDD LT6010AIDD | | LT6010CS8 LT6010IS8 LT6010ACS8 LT6010AIS8 |
| | DD PART MARKING* | | S8 PART MARKING |
| LADU | 6010 6010I 6010A 6010AI | | |

*Temperature grades are identified by a label on the shipping container.
Consult LTC Marketing for parts specified with wider operating temperature ranges.

ELECTRICAL CHARACTERISTICS

The ● denotes the specifications which apply over the full operating temperature range, otherwise specifications are at $T_A = 25^{\circ}\text{C}$. $V_S = 5\text{V}$, 0V ; $V_{CM} = 2.5\text{V}$; R_L to 0V ; $\text{SHDN} = 0.2\text{V}$, unless otherwise specified. (Note 5)

| SYMBOL | PARAMETER | CONDITIONS | MIN | TYP | MAX | UNITS |
|--------------------------|-------------------------------------|---|-----|-----|--------------------------------|--------------------------------|
| V_{OS} | Input Offset Voltage (Note 7) | LT6010AS8 $T_A = 0^{\circ}\text{C}$ to 70°C $T_A = -40^{\circ}\text{C}$ to 85°C | ● | 10 | 35 | μV |
| | | ● | | 60 | μV | |
| | | ● | | 75 | μV | |
| | | ● | | | | |
| | | LT6010S8 $T_A = 0^{\circ}\text{C}$ to 70°C $T_A = -40^{\circ}\text{C}$ to 85°C | ● | 20 | 55 | μV |
| | | ● | | 85 | μV | |
| | | ● | | 110 | μV | |
| | | ● | | | | |
| | | LT6010ADD $T_A = 0^{\circ}\text{C}$ to 70°C $T_A = -40^{\circ}\text{C}$ to 85°C | ● | 20 | 60 | μV |
| | | ● | | 85 | μV | |
| | | ● | | 100 | μV | |
| | | ● | | | | |
| | | LT6010DD $T_A = 0^{\circ}\text{C}$ to 70°C $T_A = -40^{\circ}\text{C}$ to 85°C | ● | 30 | 80 | μV |
| | | ● | | 110 | μV | |
| | | ● | | 135 | μV | |
| | | ● | | | | |
| $\Delta V_{OS}/\Delta T$ | Input Offset Voltage Drift (Note 6) | LT6010AS8, LT6010S8 | ● | 0.2 | 0.8 | $\mu\text{V}/^{\circ}\text{C}$ |
| | | ● | 0.2 | 1.3 | $\mu\text{V}/^{\circ}\text{C}$ | |

ELECTRICAL CHARACTERISTICS

The ● denotes the specifications which apply over the full operating temperature range, otherwise specifications are at $T_A = 25^\circ\text{C}$. $V_S = 5\text{V}$, 0V ; $V_{CM} = 2.5\text{V}$; R_L to 0V ; $\text{SHDN} = 0.2\text{V}$, unless otherwise specified. (Note 5)

| SYMBOL | PARAMETER | CONDITIONS | MIN | TYP | MAX | UNITS |
|---|---|---|-----|-----------|-----------|------------------------|
| I_{OS} | Input Offset Current (Note 7) | LT6010AS8 $T_A = 0^\circ\text{C}$ to 70°C ● $T_A = -40^\circ\text{C}$ to 85°C ● | | 20 | 110 | pA |
| | | | | | 150 | pA |
| | | | | | 200 | pA |
| | | LT6010S8 $T_A = 0^\circ\text{C}$ to 70°C ● $T_A = -40^\circ\text{C}$ to 85°C ● | | 40 | 200 | pA |
| | | | | 300 | pA | |
| | | | | 400 | pA | |
| | LT6010ADD $T_A = 0^\circ\text{C}$ to 70°C ● $T_A = -40^\circ\text{C}$ to 85°C ● | | | 20 | 200 | pA |
| | | | | | 300 | pA |
| | | | | | 400 | pA |
| | | LT6010DD $T_A = 0^\circ\text{C}$ to 70°C ● $T_A = -40^\circ\text{C}$ to 85°C ● | | 40 | 300 | pA |
| | | | | 400 | pA | |
| | | | | 500 | pA | |
| I_B | Input Bias Current (Note 7) | LT6010AS8 $T_A = 0^\circ\text{C}$ to 70°C ● $T_A = -40^\circ\text{C}$ to 85°C ● | | 20 | ± 110 | pA |
| | | | | | ± 150 | pA |
| | | | | | ± 200 | pA |
| | | LT6010S8 $T_A = 0^\circ\text{C}$ to 70°C ● $T_A = -40^\circ\text{C}$ to 85°C ● | | 40 | ± 200 | pA |
| | | | | ± 300 | pA | |
| | | | | ± 400 | pA | |
| | LT6010ADD $T_A = 0^\circ\text{C}$ to 70°C ● $T_A = -40^\circ\text{C}$ to 85°C ● | | | 20 | ± 200 | pA |
| | | | | | ± 300 | pA |
| | | | | | ± 400 | pA |
| | | LT6010DD $T_A = 0^\circ\text{C}$ to 70°C ● $T_A = -40^\circ\text{C}$ to 85°C ● | | 40 | ± 300 | pA |
| | | | | ± 400 | pA | |
| | | | | ± 500 | pA | |
| | Input Noise Voltage | 0.1Hz to 10Hz | | 400 | | nV _{p-p} |
| e_n | Input Noise Voltage Density | f = 1kHz | | 14 | | nV/ $\sqrt{\text{Hz}}$ |
| i_n | Input Noise Current Density | f = 1kHz | | 0.1 | | pA/ $\sqrt{\text{Hz}}$ |
| R_{IN} | Input Resistance | Common Mode, $V_{CM} = 1\text{V}$ to 3.8V | 10 | 120 | | G Ω |
| | | Differential | | 20 | | M Ω |
| C_{IN} | Input Capacitance | | | 4 | | pF |
| V_{CM} | Input Voltage Range (Positive) | Guaranteed by CMRR ● | 3.8 | 4 | | V |
| | Input Voltage Range (Negative) | Guaranteed by CMRR ● | | 0.7 | 1 | V |
| CMRR | Common Mode Rejection Ratio | $V_{CM} = 1\text{V}$ to 3.8V ● | 107 | 135 | | dB |
| | Minimum Supply Voltage | Guaranteed by PSRR ● | | 2.4 | 2.7 | V |
| PSRR | Power Supply Rejection Ratio | $V_S = 2.7\text{V}$ to 36V , $V_{CM} = 1/2V_S$ ● | 112 | 135 | | dB |
| A_{VOL} | Large-Signal Voltage Gain | $R_L = 10\text{k}$, $V_{OUT} = 1\text{V}$ to 4V ● | 300 | 2000 | | V/mV |
| | | $R_L = 2\text{k}$, $V_{OUT} = 1\text{V}$ to 4V ● | 250 | 2000 | | V/mV |
| V_{OUT} | Maximum Output Swing (Positive, Referred to V^+) | No Load, 50mV Overdrive ● | | 35 | 55 | mV |
| | | | | | 65 | mV |
| | $I_{SOURCE} = 1\text{mA}$, 50mV Overdrive ● | | | 120 | 170 | mV |
| | | | | | 220 | mV |
| Maximum Output Swing (Negative, Referred to 0V) | No Load, 50mV Overdrive ● | | 40 | 55 | mV | |
| | | | | 65 | mV | |
| | $I_{SINK} = 1\text{mA}$, 50mV Overdrive ● | | 150 | 225 | mV | |
| | | | | 275 | mV | |

ELECTRICAL CHARACTERISTICS

The ● denotes the specifications which apply over the full operating temperature range, otherwise specifications are at $T_A = 25^\circ\text{C}$. $V_S = 5\text{V}$, 0V ; $V_{\text{CM}} = 2.5\text{V}$; R_L to 0V ; $\text{SHDN} = 0.2\text{V}$, unless otherwise specified. (Note 5)

| SYMBOL | PARAMETER | CONDITIONS | MIN | TYP | MAX | UNITS |
|-------------------|---------------------------------------|--|-----------------|----------------------|------|--|
| I_{SC} | Output Short-Circuit Current (Note 3) | $V_{\text{OUT}} = 0\text{V}$, 1V Overdrive (Source) | ● 10 4 | 14 | | mA mA |
| | | $V_{\text{OUT}} = 5\text{V}$, -1V Overdrive (Sink) | ● 10 4 | 21 | | mA mA |
| SR | Slew Rate | $A_V = -10$, $R_F = 50\text{k}$, $R_G = 5\text{k}$ $T_A = 0^\circ\text{C}$ to 70°C $T_A = -40^\circ\text{C}$ to 85°C | ● ● ● | 0.06 0.05 0.04 | 0.09 | V/ μs V/ μs V/ μs |
| GBW | Gain Bandwidth Product | $f = 10\text{kHz}$ | ● 250 225 | 330 | | kHz kHz |
| t_s | Settling Time | $A_V = -1$, 0.01%, $V_{\text{OUT}} = 1.5\text{V}$ to 3.5V | | 45 | | μs |
| t_r , t_f | Rise Time, Fall Time | $A_V = 1$, 10% to 90%, 0.1V Step | | 1 | | μs |
| I_{SHDN} | SHDN Pin Current | $\text{SHDN} \leq V^- + 0.2\text{V}$ (On) | ● | | 0.25 | μA |
| | | $\text{SHDN} = V^- + 2.0\text{V}$ (Off) | ● | 15 | 25 | μA |
| t_{SHDN} | SHDN Turn-On, Turn-Off Time | $\text{SHDN} = V^-$ (On) to $V^- + 2.0\text{V}$ (Off) | | 25 | | μs |
| | | $\text{SHDN} = V^- + 2.0\text{V}$ (Off) to V^- (On) | | 25 | | μs |
| I_S | Supply Current | $\text{SHDN} \leq V^- + 0.2\text{V}$ (On) $T_A = 0^\circ\text{C}$ to 70°C $T_A = -40^\circ\text{C}$ to 85°C | ● ● ● | 135 | 150 | μA μA μA |
| | | $\text{SHDN} = V^- + 2.0\text{V}$ (Off) | ● | 12 | 25 | μA |
| | | | | | 50 | μA |

The ● denotes the specifications which apply over the full operating temperature range, otherwise specifications are at $T_A = 25^\circ\text{C}$. $V_S = \pm 15\text{V}$, $V_{\text{CM}} = 0\text{V}$, R_L to 0V ; $\text{SHDN} = -14.8\text{V}$, unless otherwise specified. (Note 5)

| SYMBOL | PARAMETER | CONDITIONS | MIN | TYP | MAX | UNITS |
|---------------------------------|-------------------------------------|---|--------|-----|-----|--|
| V_{OS} | Input Offset Voltage (Note 7) | LT6010AS8 $T_A = 0^\circ\text{C}$ to 70°C $T_A = -40^\circ\text{C}$ to 85°C | ● ● | 10 | 60 | μV μV μV |
| | | LT6010S8 $T_A = 0^\circ\text{C}$ to 70°C $T_A = -40^\circ\text{C}$ to 85°C | ● ● | 20 | 85 | μV μV μV |
| | | LT6010ADD $T_A = 0^\circ\text{C}$ to 70°C $T_A = -40^\circ\text{C}$ to 85°C | ● ● | 20 | 85 | μV μV μV |
| | | LT6010DD $T_A = 0^\circ\text{C}$ to 70°C $T_A = -40^\circ\text{C}$ to 85°C | ● ● | 30 | 110 | μV μV μV |
| $\Delta V_{\text{OS}}/\Delta T$ | Input Offset Voltage Drift (Note 6) | LT6010AS8, LT6010S8 LT6010ADD, LT6010DD | ● ● | 0.2 | 0.8 | $\mu\text{V}/^\circ\text{C}$ $\mu\text{V}/^\circ\text{C}$ |
| | | | | 0.2 | 1.3 | |
| I_{OS} | Input Offset Current (Note 7) | LT6010AS8 $T_A = 0^\circ\text{C}$ to 70°C $T_A = -40^\circ\text{C}$ to 85°C | ● ● | 20 | 110 | pA pA pA |
| | | LT6010S8 $T_A = 0^\circ\text{C}$ to 70°C $T_A = -40^\circ\text{C}$ to 85°C | ● ● | 40 | 200 | pA pA pA |
| | | LT6010ADD $T_A = 0^\circ\text{C}$ to 70°C $T_A = -40^\circ\text{C}$ to 85°C | ● ● | 20 | 200 | pA pA pA |

ELECTRICAL CHARACTERISTICS The ● denotes the specifications which apply over the full operating temperature range, otherwise specifications are at $T_A = 25^\circ\text{C}$. $V_S = \pm 15\text{V}$, $V_{CM} = 0\text{V}$, R_L to 0V ; $\text{SHDN} = -14.8\text{V}$, unless otherwise specified. (Note 5)

| SYMBOL | PARAMETER | CONDITIONS | MIN | TYP | MAX | UNITS |
|---|---|--|--------------|---------------|------------|------------------------------|
| I_{OS} | Input Offset Current (Note 7) | LT6010DD | | 40 | 300 | μA |
| | | $T_A = 0^\circ\text{C}$ to 70°C | ● | | 400 | μA |
| | | $T_A = -40^\circ\text{C}$ to 85°C | ● | | 500 | μA |
| I_B | Input Bias Current (Note 7) | LT6010AS8 | | 20 | ± 110 | μA |
| | | $T_A = 0^\circ\text{C}$ to 70°C | ● | | ± 150 | μA |
| | | $T_A = -40^\circ\text{C}$ to 85°C | ● | | ± 200 | μA |
| | | LT6010S8 | | 40 | ± 200 | μA |
| | | $T_A = 0^\circ\text{C}$ to 70°C | ● | | ± 300 | μA |
| | | $T_A = -40^\circ\text{C}$ to 85°C | ● | | ± 400 | μA |
| | | LT6010ADD | | 20 | ± 200 | μA |
| | | $T_A = 0^\circ\text{C}$ to 70°C | ● | | ± 300 | μA |
| $T_A = -40^\circ\text{C}$ to 85°C | ● | | ± 400 | μA | | |
| | Input Noise Voltage | 0.1Hz to 10Hz | | 400 | | $\text{nV}_{\text{p-p}}$ |
| e_n | Input Noise Voltage Density | $f = 1\text{kHz}$ | | 13 | | $\text{nV}/\sqrt{\text{Hz}}$ |
| i_n | Input Noise Current Density | $f = 1\text{kHz}$ | | 0.1 | | $\text{pA}/\sqrt{\text{Hz}}$ |
| R_{IN} | Input Resistance | Common Mode, $V_{CM} = \pm 13.5\text{V}$ | 50 | 400 | | $\text{G}\Omega$ |
| | | Differential | | 20 | | $\text{M}\Omega$ |
| C_{IN} | Input Capacitance | | | 4 | | pF |
| V_{CM} | Input Voltage Range | Guaranteed by CMRR | ● ± 13.5 | ± 14 | | V |
| CMRR | Common Mode Rejection Ratio | $V_{CM} = -13.5\text{V}$ to 13.5V | ● | 115 | 135 | dB |
| | | | ● | 112 | | dB |
| | Minimum Supply Voltage | Guaranteed by PSRR | ● | ± 1.2 | ± 1.35 | V |
| PSRR | Power Supply Rejection Ratio | $V_S = \pm 1.35\text{V}$ to $\pm 18\text{V}$ | ● | 112 | 135 | dB |
| A_{VOL} | Large-Signal Voltage Gain | $R_L = 10\text{k}$, $V_{OUT} = -13.5\text{V}$ to 13.5V | ● | 1000 | 2000 | V/mV |
| | | $R_L = 5\text{k}$, $V_{OUT} = -13.5\text{V}$ to 13.5V | ● | 600 | | V/mV |
| V_{OUT} | Maximum Output Swing (Positive, Referred to V^+) | No Load, 50mV Overdrive | ● | 45 | 80 | mV |
| | | $I_{SOURCE} = 1\text{mA}$, 50mV Overdrive | ● | 140 | 195 | mV |
| | Maximum Output Swing (Negative, Referred to 0V) | No Load, 50mV Overdrive | ● | 45 | 80 | mV |
| | | $I_{SINK} = 1\text{mA}$, 50mV Overdrive | ● | 150 | 250 | mV |
| I_{SC} | Output Short-Circuit Current (Note 3) | $V_{OUT} = 0\text{V}$, 1V Overdrive (Source) | ● | 10 | 15 | mA |
| | | $V_{OUT} = 0\text{V}$, -1V Overdrive (Sink) | ● | 5 | | mA |
| | | | ● | 10 | 20 | mA |
| | | | ● | 5 | | mA |

ELECTRICAL CHARACTERISTICS

The ● denotes the specifications which apply over the full operating temperature range, otherwise specifications are at $T_A = 25^\circ\text{C}$. $V_S = \pm 15\text{V}$, $V_{\text{CM}} = 0\text{V}$, R_L to 0V ; $\text{SHDN} = -14.8\text{V}$, unless otherwise specified. (Note 5)

| SYMBOL | PARAMETER | CONDITIONS | MIN | TYP | MAX | UNITS |
|-------------------|-----------------------------|--|--------|------|------|------------------|
| SR | Slew Rate | $A_V = -10$, $R_F = 50\text{k}$, $R_G = 5\text{k}$ | 0.08 | 0.11 | | V/ μs |
| | | $T_A = 0^\circ\text{C}$ to 70°C | ● 0.07 | | | V/ μs |
| | | $T_A = -40^\circ\text{C}$ to 85°C | ● 0.05 | | | V/ μs |
| GBW | Gain Bandwidth Product | $f = 10\text{kHz}$ | 275 | 350 | | kHz |
| | | | ● 250 | | | kHz |
| t_s | Settling Time | $A_V = -1$, 0.01% , $V_{\text{OUT}} = 0\text{V}$ to 10V | | 85 | | μs |
| t_r , t_f | Rise Time, Fall Time | $A_V = 1$, 10% to 90% , 0.1V Step | | 1 | | μs |
| I_{SHDN} | SHDN Pin Current | $\text{SHDN} \leq V^- + 0.2\text{V}$ (On) | ● | | 0.25 | μA |
| | | $\text{SHDN} = V^- + 2.0\text{V}$ (Off) | ● | 15 | 25 | μA |
| t_{SHDN} | SHDN Turn-On, Turn-Off Time | $\text{SHDN} = V^-$ (On) to $V^- + 2.0\text{V}$ (Off) | | 25 | | μs |
| | | $\text{SHDN} = V^- + 2.0\text{V}$ (Off) to V^- (On) | | 25 | | μs |
| I_S | Supply Current | $\text{SHDN} \leq V^- + 0.2\text{V}$ (On) | | 260 | 330 | μA |
| | | $T_A = 0^\circ\text{C}$ to 70°C | ● | | 380 | μA |
| | | $T_A = -40^\circ\text{C}$ to 85°C | ● | | 400 | μA |
| | | $\text{SHDN} = V^- + 2.0\text{V}$ (Off) | | 18 | 50 | μA |

Note 1: Absolute Maximum Ratings are those beyond which the life of the device may be impaired.

Note 2: The inputs are protected by back-to-back diodes and internal series resistors. If the differential input voltage exceeds 10V , the input current must be limited to less than 10mA .

Note 3: A heat sink may be required to keep the junction temperature below absolute maximum ratings.

Note 4: Both the LT6010C and LT6010I are guaranteed functional over the operating temperature range of -40°C to 85°C .

Note 5: The LT6010C is guaranteed to meet the specified performance

from 0°C to 70°C and is designed, characterized and expected to meet specified performance from -40°C to 85°C but is not tested or QA sampled at these temperatures. The LT6010I is guaranteed to meet specified performance from -40°C to 85°C .

Note 6: This parameter is not 100% tested.

Note 7: The specifications for V_{OS} , I_B and I_{OS} depend on the grade and on the package. The following table clarifies the notations used in the specification table:

| | Standard Grade | A Grade |
|-------------|----------------|-----------|
| S8 Package | LT6010S8 | LT6010AS8 |
| DFN Package | LT6010DD | LT6010ADD |

TYPICAL PERFORMANCE CHARACTERISTICS

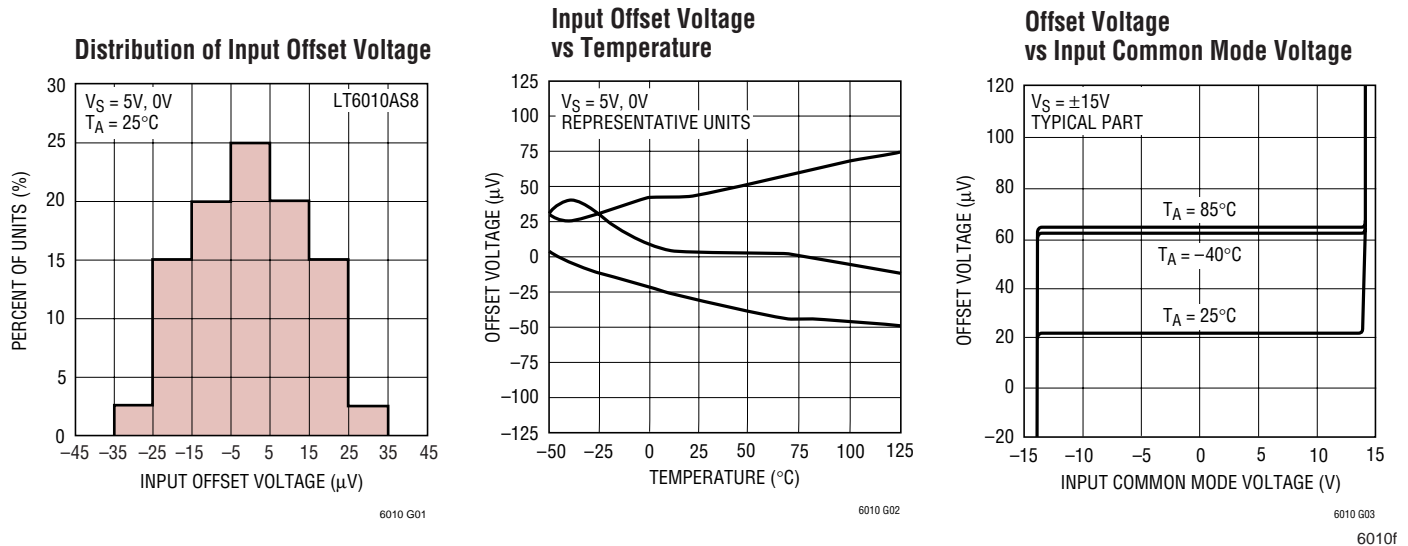

TYPICAL PERFORMANCE CHARACTERISTICS

Input Bias Current vs Temperature

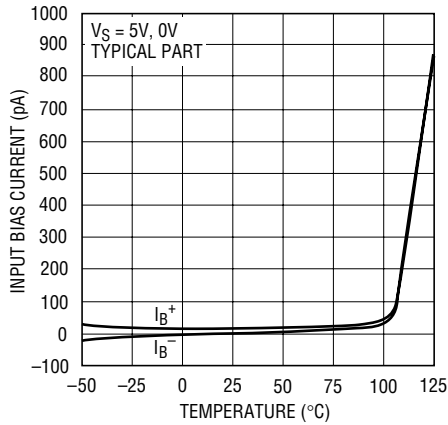

6010 G04

Input Bias Current vs Input Common Mode Voltage

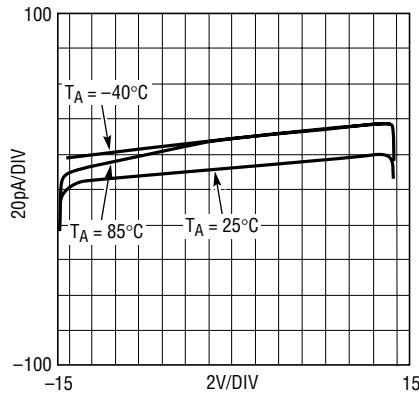

6010 G05

e_n, i_n vs Frequency

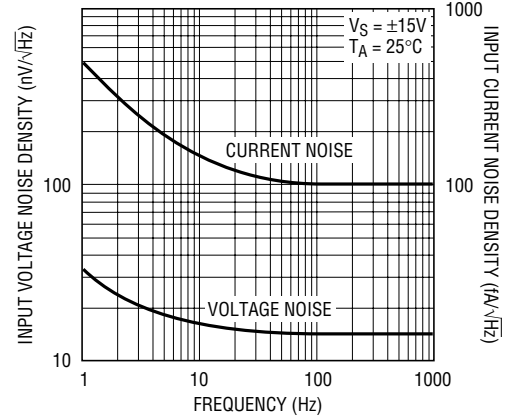

6010 G06

Total Input Noise vs Source Resistance

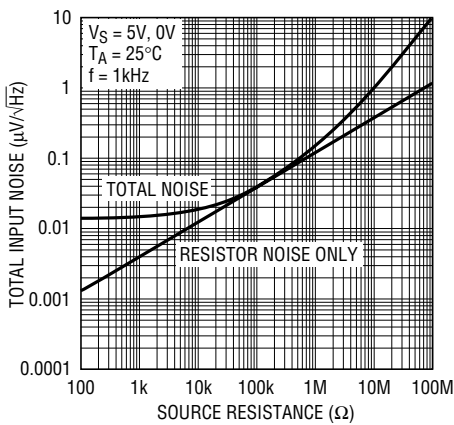

6010 G07

0.1Hz to 10Hz Noise

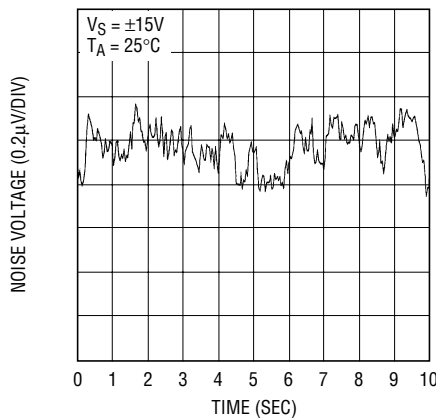

6010 G08

0.01Hz to 1Hz Noise

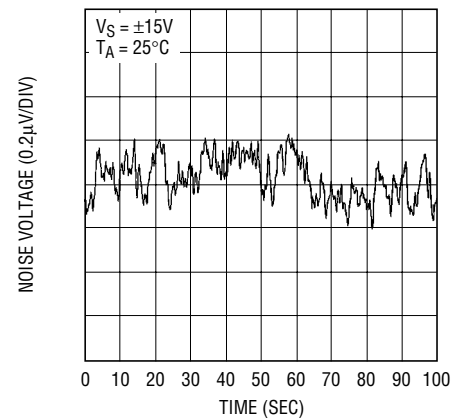

6010 G09

Output Voltage Swing vs Temperature

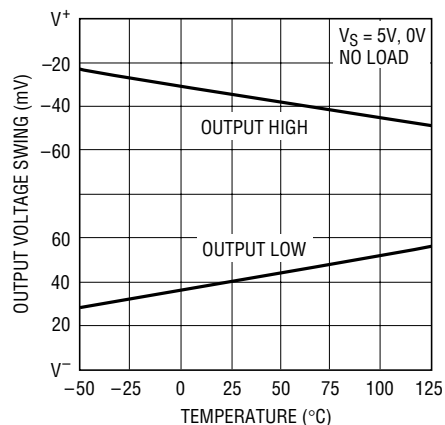

6010 G10

Output Saturation Voltage vs Load Current (Output High)

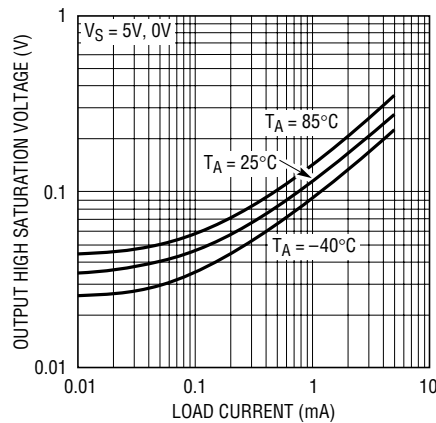

6010 G11

Output Saturation Voltage vs Load Current (Output Low)

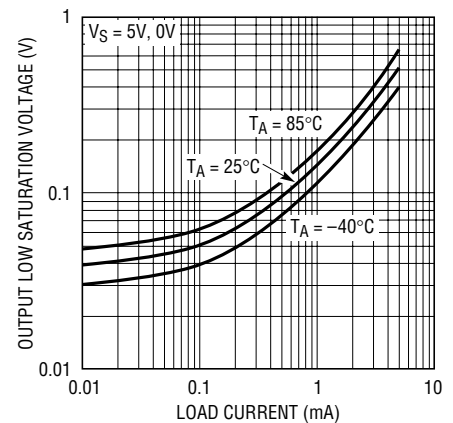

6010 G12

TYPICAL PERFORMANCE CHARACTERISTICS

Supply Current vs Supply Voltage

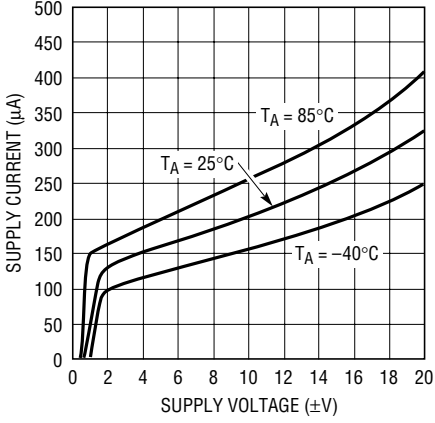

6010 G13

Warm-Up Drift

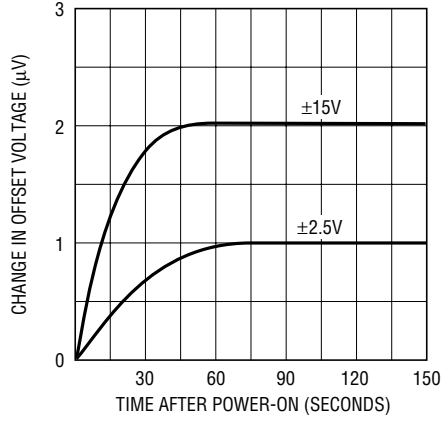

6010 G14

THD + Noise vs Frequency

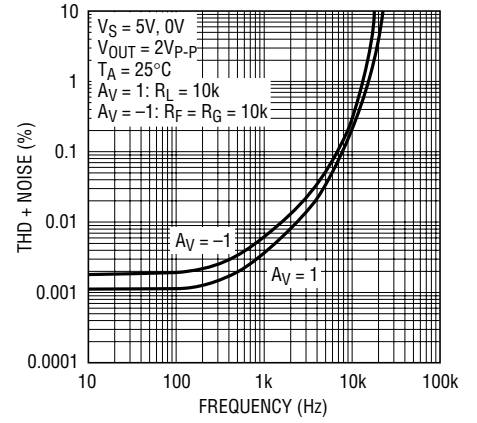

6010 G15

THD + Noise vs Frequency

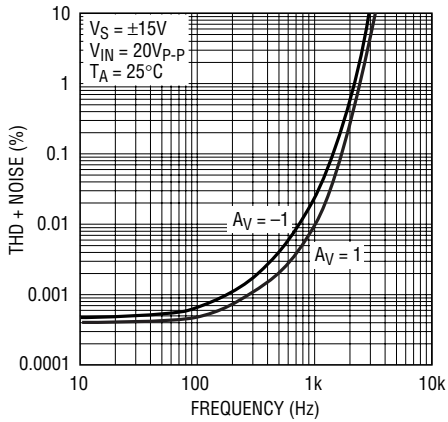

6010 G16

Settling Time vs Output Step

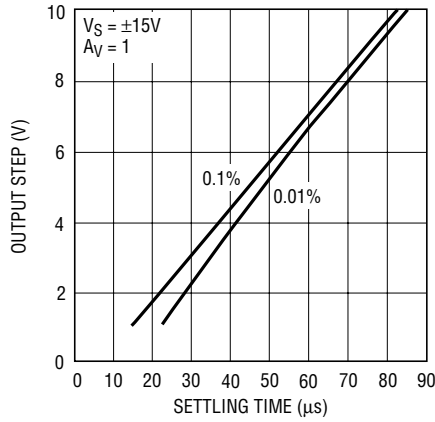

6010 G17

Settling Time vs Output Step

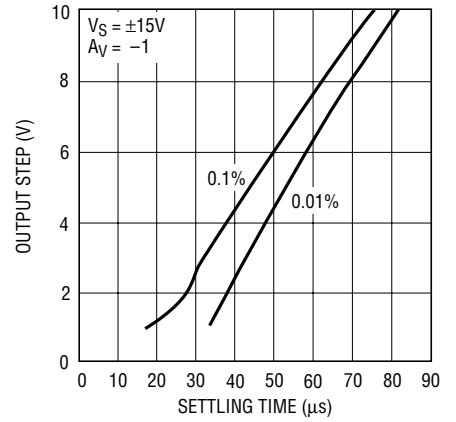

6010 G18

CMRR vs Frequency

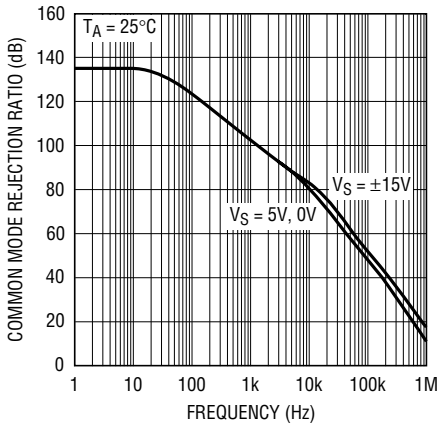

6010 G20

PSRR vs Frequency

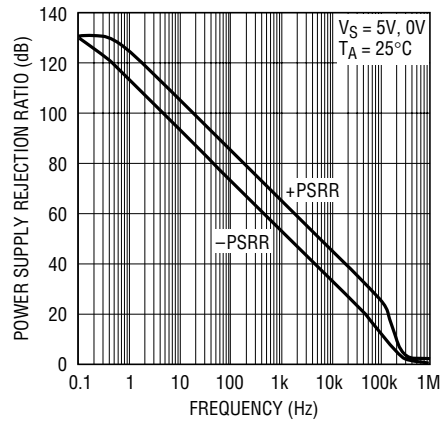

6010 G21

TYPICAL PERFORMANCE CHARACTERISTICS

Output Impedance vs Frequency

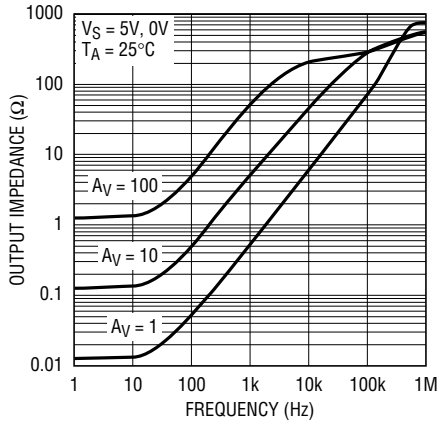

6010 G22

Open-Loop Gain vs Frequency

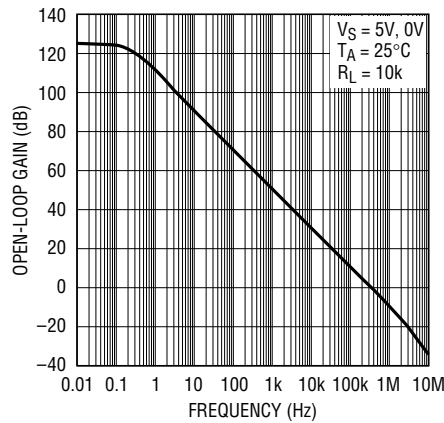

6010 G23

Gain and Phase vs Frequency

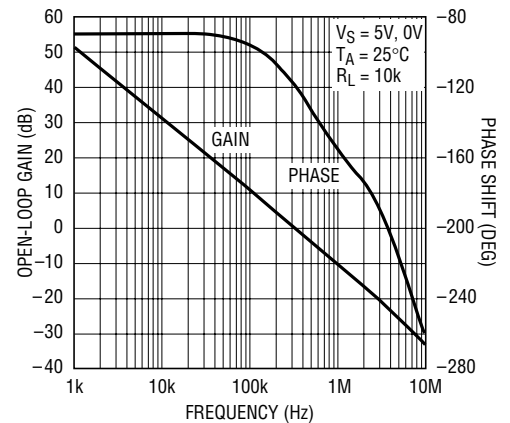

6010 G24

Gain vs Frequency, $A_V = 1$

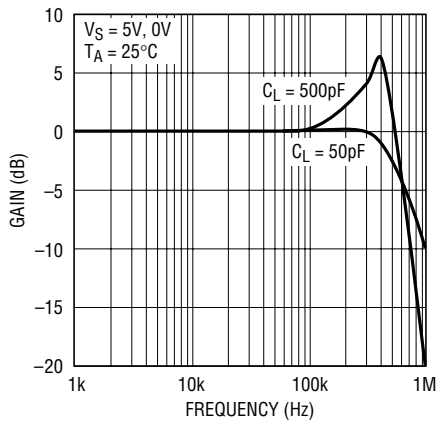

6010 G25

Gain vs Frequency, $A_V = -1$

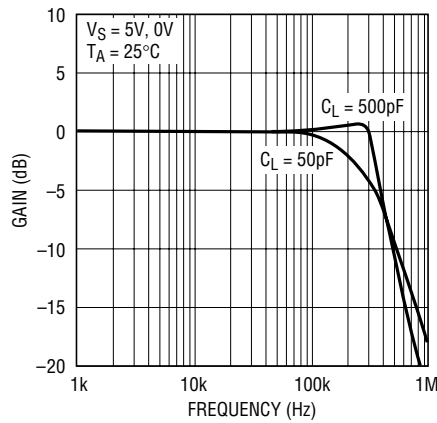

6010 G26

Supply Current in Shutdown Mode vs Temperature

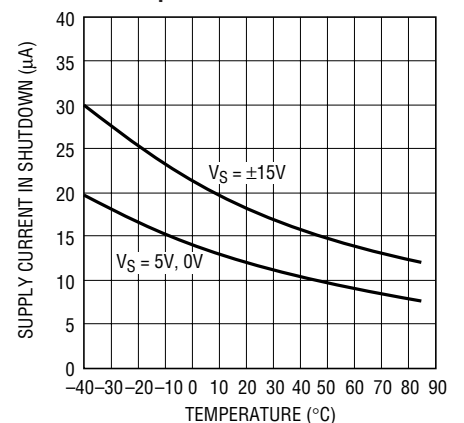

6010 G30

Small-Signal Transient Response

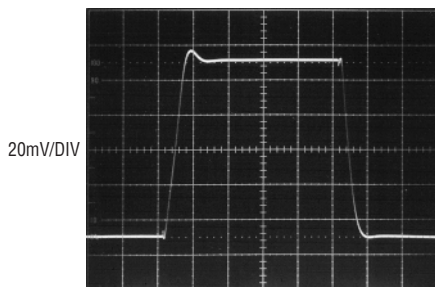

$A_V = 1$ 2 μs /DIV 6011 G27

Large-Signal Transient Response

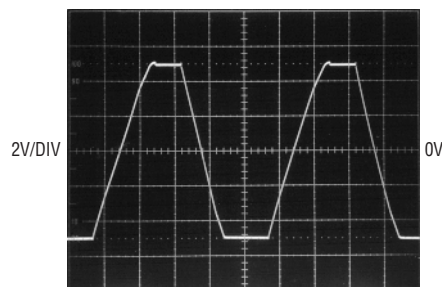

$A_V = -1$ 50 μs /DIV 6011 G28
 $V_S = \pm 15V$

Rail-to-Rail Output Swing

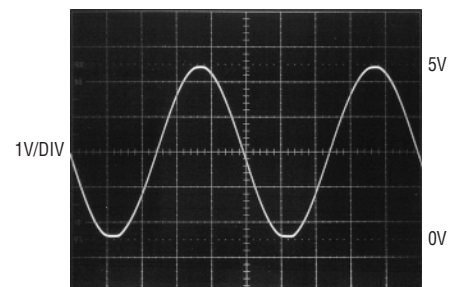

$A_V = -1$ 100 μs /DIV 6011 G29
 $V_S = 5V, 0V$

APPLICATIONS INFORMATION

Preserving Input Precision

Preserving the input accuracy of the LT6010 requires that the applications circuit and PC board layout do not introduce errors comparable to or greater than the 20 μ V typical offset of the amplifier. Temperature differentials across the input connections can generate thermocouple voltages of 10's of microvolts, so the connections to the input leads should be short, close together, and away from heat dissipating components. Air currents across the board can also generate temperature differentials.

The extremely low input bias currents (20pA typical) allow high accuracy to be maintained with high impedance sources and feedback resistors. The LT6010 low input bias currents are obtained by a cancellation circuit on-chip. The input bias currents are permanently trimmed at wafer testing to a low level. Do not try to balance the input resistances in each input lead; instead, keep the resistance at either input as low as possible for maximum accuracy.

Leakage currents on the PC board can be higher than the LT6010's input bias current. For example, 10G Ω of leakage between a 15V supply lead and an input lead will generate 1.5nA! Surround the input leads by a guard ring, driven to the same potential as the input common mode, to avoid excessive leakage in high impedance applications.

Input Protection

The LT6010 features on-chip back-to-back diodes between the input devices, along with 500 Ω resistors in series with either input. This internal protection limits the input current to approximately 10mA (the maximum

allowed) for a 10V differential input voltage. Use additional external series resistors to limit the input current to 10mA in applications where differential inputs of more than 10V are expected. For example, a 1k resistor in series with each input provides protection against 30V differential voltage.

Input Common Mode Range

The LT6010 output is able to swing nearly to each power supply rail (rail-to-rail out), but the input stage is limited to operating between $V^- + 1V$ and $V^+ - 1.2V$. Exceeding this common mode range will cause the gain to drop to zero, however no phase reversal will occur.

Total Input Noise

The LT6010 amplifier contributes negligible noise to the system when driven by sensors (sources) with impedance between 20k Ω and 1M Ω . Throughout this range, total input noise is dominated by the 4kTR_S noise of the source. If the source impedance is less than 20k Ω , the input voltage noise of the amplifier starts to contribute with a minimum noise of 14nV/ $\sqrt{\text{Hz}}$ for very low source impedance. If the source impedance is more than 1M Ω , the input current noise of the amplifier, multiplied by this high impedance, starts to contribute and eventually dominate. Total input noise spectral density can be calculated as:

$$v_{n(\text{TOTAL})} = \sqrt{e_n^2 + 4kTR_S + (i_n R_S)^2}$$

where $e_n = 14\text{nV}/\sqrt{\text{Hz}}$, $i_n = 0.1\text{pA}/\sqrt{\text{Hz}}$ and R_S the total impedance at the input, including the source impedance.

APPLICATIONS INFORMATION

Offset Voltage Adjustment

The input offset voltage of the LT6010 and its drift with temperature are permanently trimmed at wafer testing to the low level as specified in the electrical characteristic. However, if further adjustment of V_{OS} is desired, nulling with a 50k potentiometer is possible and will not degrade drift with temperature. Trimming to a value other than zero

creates a drift of $(V_{OS}/300\mu V)\mu V/^\circ C$, e.g., if V_{OS} is adjusted to $300\mu V$, the change in drift will be $1\mu V/^\circ C$. The adjustment range with a 50k pot is approximately $\pm 0.9mV$ (see Figures 1A and 1B). The sensitivity and resolution of the nulling can be improved by using a smaller pot in conjunction with fixed resistors. The configuration shown has an approximate nulling range of $\pm 150\mu V$ (see Figures 2A and 2B).

Standard Adjustment

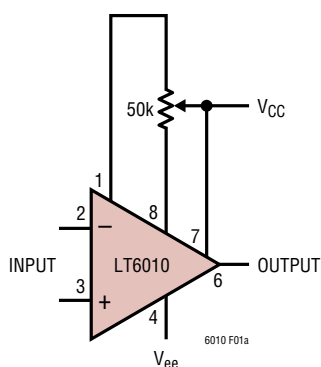

Figure 1A

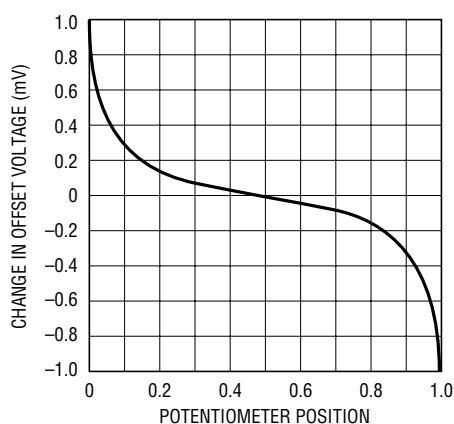

Figure 1B

Improved Sensitivity Adjustment

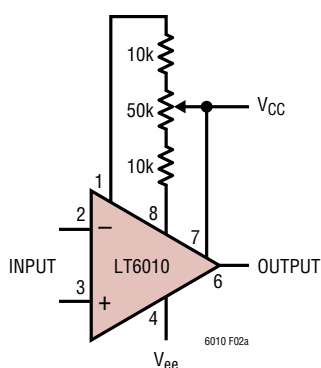

Figure 2A

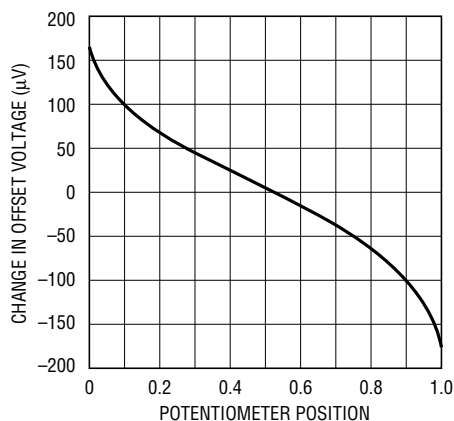

Figure 2B

APPLICATIONS INFORMATION

Shutdown

The LT6010 can be put into shutdown mode to conserve power. When the SHDN pin is biased at less than 0.2V above the negative supply, the part operates normally. When pulled 2V or more above V^- , the supply current drops to about 12 μ A, shutting down the op amp.

The output of the LT6010 op amp is not isolated from the inputs while in shutdown mode. Therefore, this shutdown feature cannot be used for multiplexing applications.

There is an internal 85k resistor at the SHDN pin. If the SHDN voltage source is more than 2V above the negative supply, an external series resistor can be placed between the source and SHDN pin to reduce SHDN pin current (see Figure 3). For an example of suggested values see Table 1. The resistors listed ensure that the voltage at the SHDN pin is 2V above the negative supply.

Table 1

| V_{SHDN} (V) | R_{SHDN} (k Ω) |
|----------------|--------------------------|
| 2 | NONE |
| 3 | 77k |
| 4 | 153k |
| 5 | 230k |

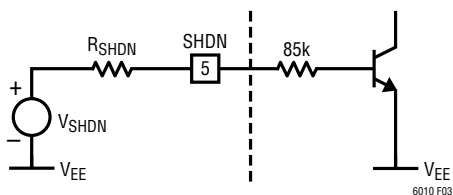

Figure 3

Capacitive Loads

The LT6010 can drive capacitive loads up to 500pF in unity gain. The capacitive load driving capability increases as the amplifier is used in higher gain configurations. A small series resistance between the output and the load further increases the amount of capacitance that the amplifier can drive.

Rail-to-Rail Operation

The LT6010 outputs can swing to within millivolts of either supply rail, but the inputs cannot. However, for most op amp configurations, the inputs need to swing less than the outputs. Figure 4 shows the basic op amp configurations, lists what happens to the op amp inputs and specifies whether or not the op amp must have rail-to-rail inputs. Select a rail-to-rail input op amp only when really necessary, because the input precision specifications are usually inferior.

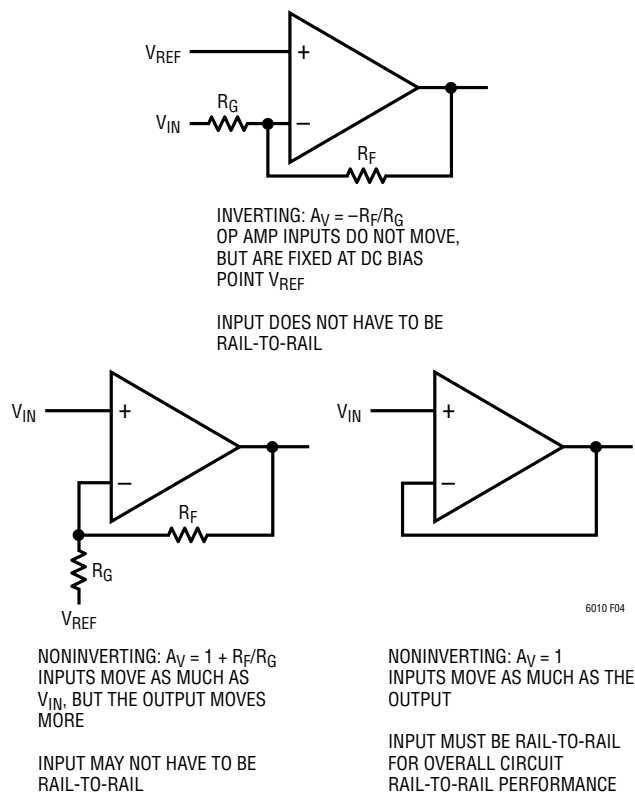
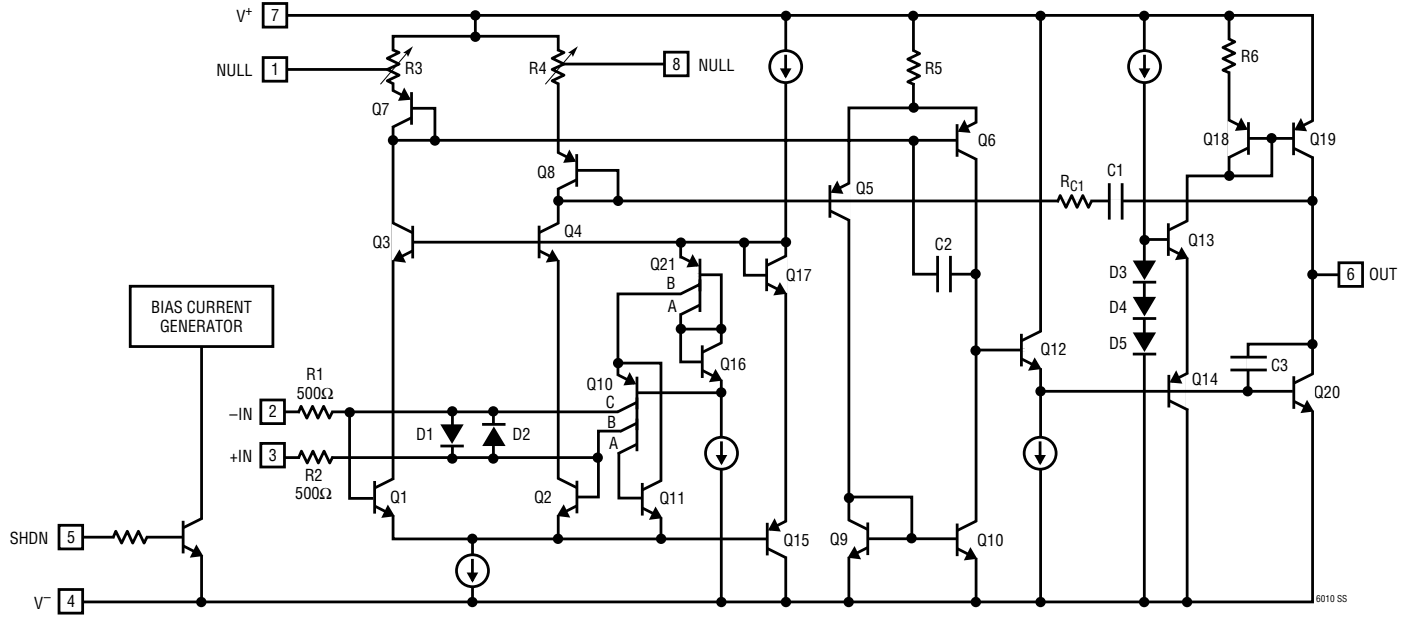

Figure 4. Some Op Amp Configurations Do Not Require Rail-to-Rail Inputs to Achieve Rail-to-Rail Outputs

SIMPLIFIED SCHEMATIC



PACKAGE DESCRIPTION

DD Package
8-Lead Plastic DFN (3mm × 3mm)
 (Reference LTC DWG # 05-08-1698)

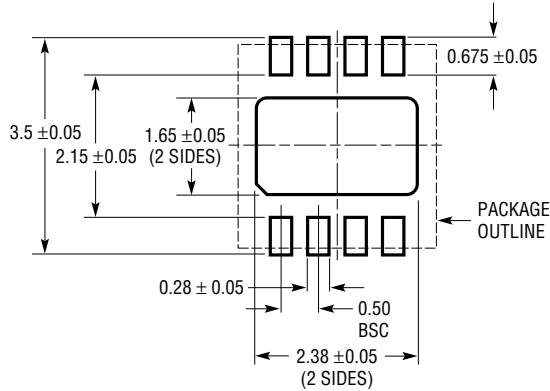

RECOMMENDED SOLDER PAD PITCH AND DIMENSIONS

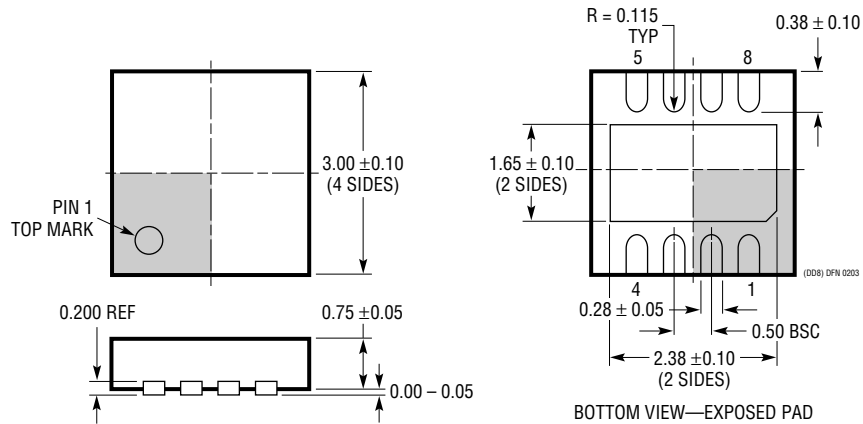

- NOTE:
1. DRAWING TO BE MADE A JEDEC PACKAGE OUTLINE M0-229 VARIATION OF (WEED-1)
 2. ALL DIMENSIONS ARE IN MILLIMETERS
 3. DIMENSIONS OF EXPOSED PAD ON BOTTOM OF PACKAGE DO NOT INCLUDE MOLD FLASH. MOLD FLASH, IF PRESENT, SHALL NOT EXCEED 0.15mm ON ANY SIDE
 4. EXPOSED PAD SHALL BE SOLDER PLATED

PACKAGE DESCRIPTION

S8 Package 8-Lead Plastic Small Outline (Narrow .150 Inch) (Reference LTC DWG # 05-08-1610)

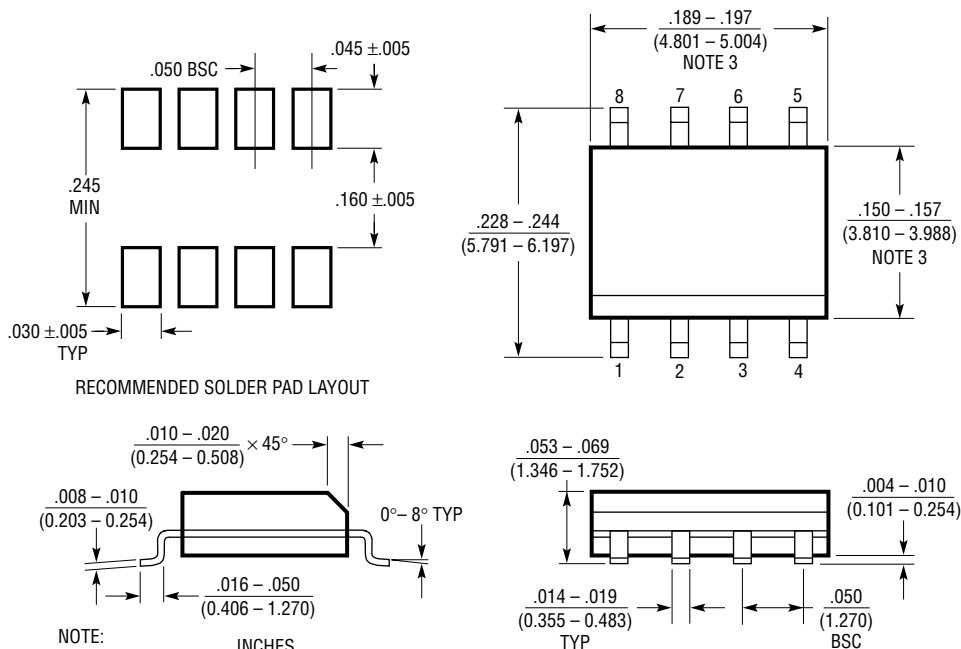

- NOTE:
1. DIMENSIONS IN $\frac{\text{INCHES}}{\text{MILLIMETERS}}$
 2. DRAWING NOT TO SCALE
 3. THESE DIMENSIONS DO NOT INCLUDE MOLD FLASH OR PROTRUSIONS. MOLD FLASH OR PROTRUSIONS SHALL NOT EXCEED .006" (0.15mm)

S08 0303

TYPICAL APPLICATION

Precision JFET Input Transimpedance Photodiode Amplifier

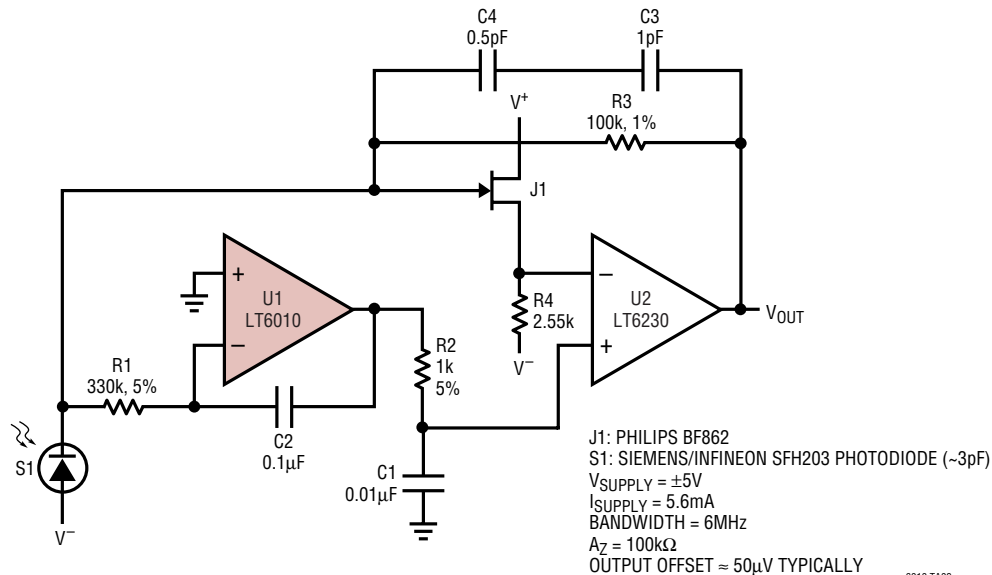

RELATED PARTS

| PART NUMBER | DESCRIPTION | COMMENTS |
|-------------|---|----------------------------|
| LT6011/6012 | Dual/Quad Precision Op Amps | 135µA, Rail-to-Rail Output |
| LT1001 | Low Power, Picoamp Input Precision Op Amp | 250pA Input Bias Current |
| LT1880 | Rail-to-Rail Output, Picoamp Input Precision Op Amp | C_{LOAD} up to 1000pF |